

Ingredients for innovation: research & entrepreneurship

# Bio-Modeling Systems

Manuel GEA, Co-founder & CEO, BIO-MODELING SYSTEMS

Vice-President Innovation ADEBIOTECH

For more information: [www.bmsystems.net](http://www.bmsystems.net) email [manuel.gea@bmsystems.net](mailto:manuel.gea@bmsystems.net)

**INNOVATION IN HEALTHCARE, FROM RESEARCH TO MARKET: SMEs IN FOCUS CONFERENCE**

**European Commission, Brussels may 20-21, 2010**

**A dual disruptive collaborative innovative approach in the field of integrative systems biology deciphered. Issues, first positive results and key learnings.**

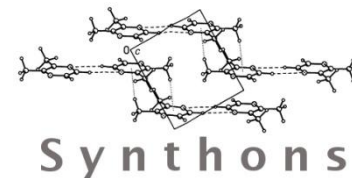

New collaborative R&D paradigm deciphered and its first operational successes in CNS, biodefense/biosecurity and Green Industrial Biotech.

# The Life-modeling issue

If you dream to create the first operational bird model...



*... a “basic” living Complex system that not only flies...*

Be sure to use the appropriate modeling concepts & tools. If not...



*...you get a Complicated “Cartesian” system. It does fly, but...*



**The challenge is clearly not a question of technologies only**

## The Life science modeling dilemma

1. The mechanisms of life are *complex, non-linear and integrative*
2. In “living complex” systems, the functions of *biological components and mechanisms are event and context-dependent*. The same components/networks can produce different biological effects
3. Classical “Cartesian” modeling concepts & approaches, valid for the majority of man-made artifacts, imply the concept of a “blue-print”. Components are “function-specific” and their assembly pattern determines the final function of the structure they constitute. *But this concept is at the opposite of biological reality*
4. ... While “Cartesian” Bioinformatics and *Mathematical tools have proven to be efficient to* collect, structure, analyze, simulate specific functions to test or to generate innovative hypotheses, yet...
5. ...The *“garbage in, garbage out” reality*, tells us that the information produced and published (even in leading scientific journals) is necessarily *ALWAYS incomplete, biased and erroneous to unknown extents*

**Despite increasing investments in Technology &I.T., major drugs products submissions to FDA are constantly declining**



We need to change our point of view

## INTERNATIONAL EXPERIENCED TEAM CHALLENGES IN 2004.

- The challenge: Create the first Integrative Systems Biology company based on a disruptive *“negative selection process”*,
- **A concept entirely contrary to “dominant” thinking.**

**Global critical issue:** *How to develop a sustainable research company when all the experts believe it is impossible ?*

### Two necessary main proofs of concept to succeed:

- **Scientific:** Create the 1<sup>st</sup> *in-silico* model of a complex human disease to be validated *in-vivo*;
- **Business:** Set up a 1<sup>st</sup> spin-off company created from an internal integrative systems biology program.



Invent a new “collaborative concept” with networked partners to support the development of CADI\*™ disruptive Research & Innovation



# BMSystems CADI™ models

*The CADI™ models are detailed maps of inter-cellular and/or intra-cellular mechanisms associated with a biological status.*

- CADI™ models are outstanding “*non-mathematical*” descriptive *in-silico* answers to explain the non-linear mechanisms of life and diseases.
- CADI™ models can describe *the dynamics of pathological processes and/or pathological mechanisms vs. control.*
- CADI™ models describe *the mechanisms that cause the diseases*, not only the consequences.
- CADI™ models *create the optimum new knowledge required to identify/explain mechanisms* that can lead to *direct industrial applications.*
- CADI™ models *have repeatedly led to novel patentable discoveries* in highly competitive applications.

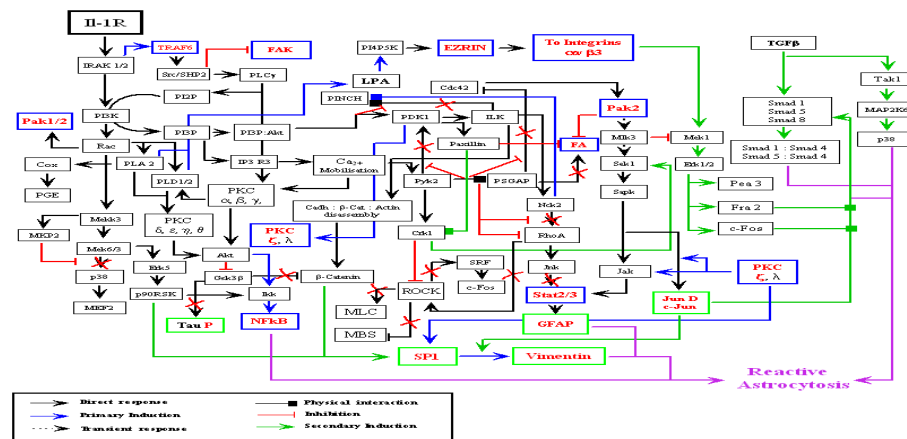

# CADI™ “ Architectural” Principles

*The efficient and reliable construction of innovative buildings.*

- *The design phase*: Architects conceive and design the building so that it obeys defined functional and structural specifications while integrating within a given environment.
- *The “blueprint” design phase*: The resulting plans are then forwarded to engineering specialists who calculate and/or test components parameters where and as required.

The resulting final blueprint is then forwarded to the contractors who then build the structure according to the blueprint specifications.

- In this analogy, *BMSystems acts as the “Architect”* while mathematical modelers and experimentalists play the complementary role of “engineering specialists”.
- As with traditional architecture, the results must be solid, useful, convenient and *have intrinsic elegance*.

By keeping to the architect's point of view and overall design attitude, BMSystems' scientists are able to succeed and solve unusual problems where traditional methods fail.

# CADI™ negative selection process

The first operational application of the negative selection concept

CADI™ original concept is an operative answer to “the garbage in garbage out issue”, and a disruptive innovative way to generate new knowledge from new cross supported hypotheses

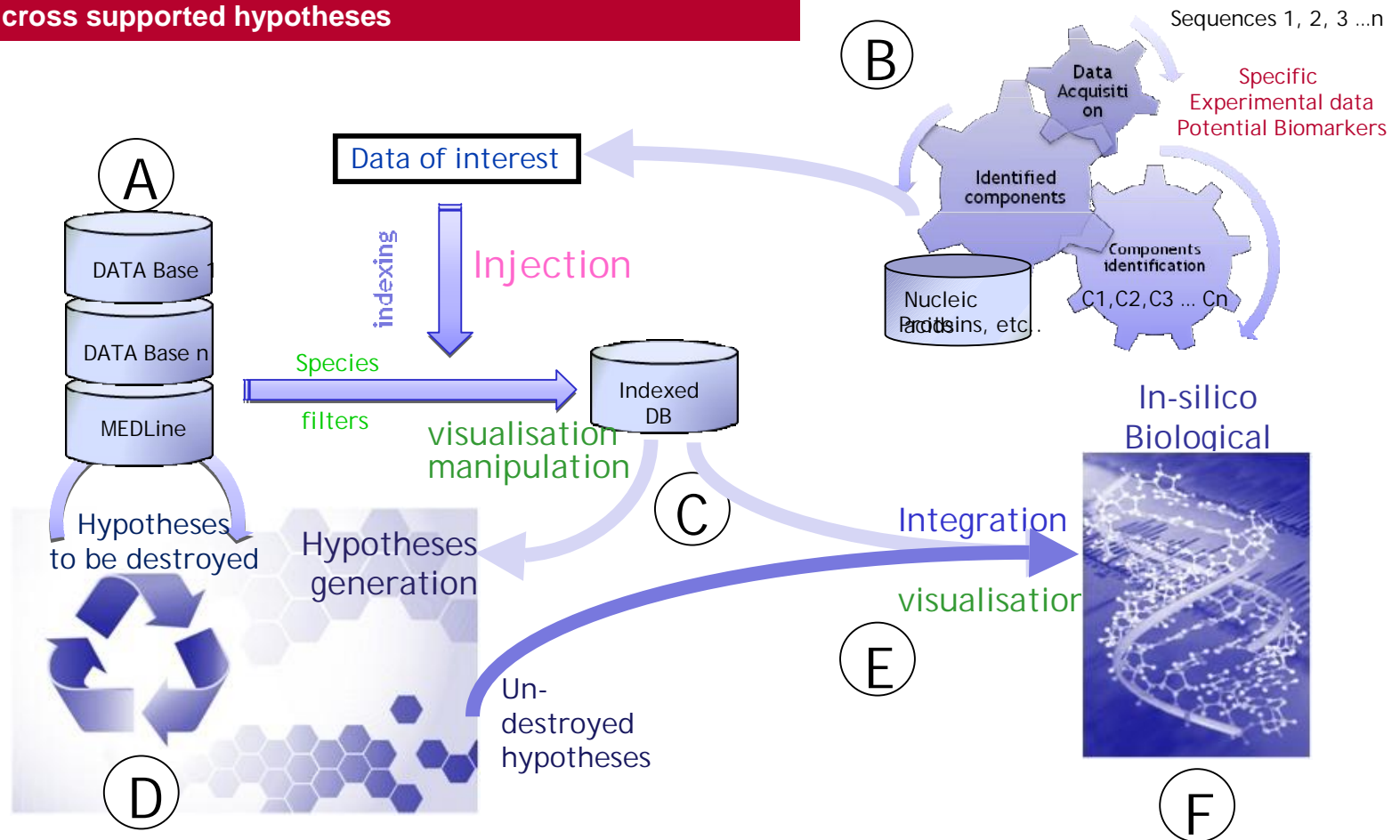

# CADI™ 4 steps validation process

➤ The CADI™ 4 steps validation process starts when the integrative biology researchers generate the initial CADI™ model, following the steps from 1 to 4:

CADI™ experimentations design

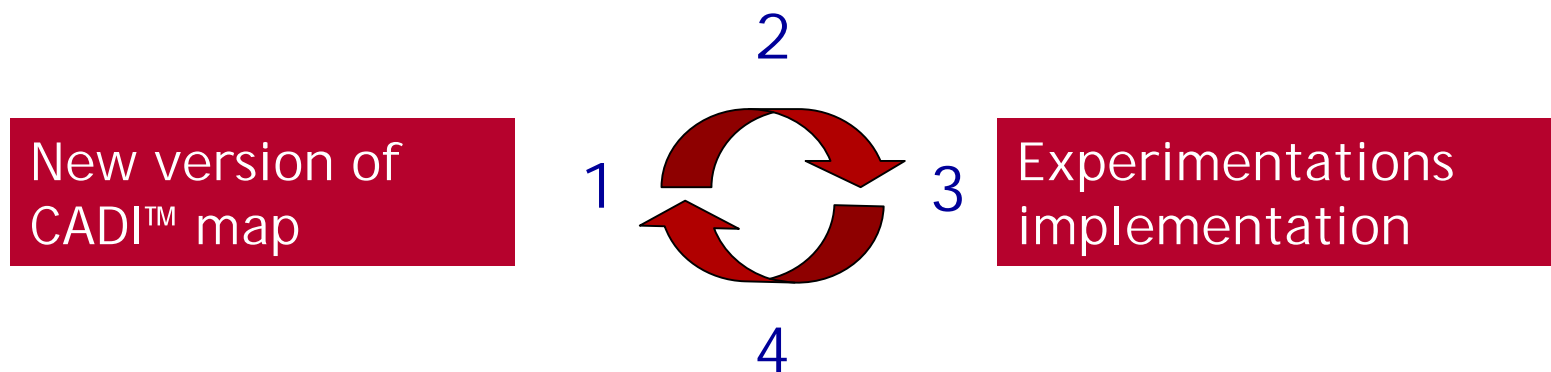

Analysis of experimental results

➤ The CADI™ 4 steps validation process stops when no key unexpected results are reported.



Now we can !

# BMSystems “ Broad life sciences & IT” Expertise

## ***A strong multidisciplinary & experienced founders team***

- *Dr. François Iris (PhD) : Chairman, CSO-CTO. Geneticist, physiologist & molecular biologist.*

Creator of Millennium Pharmaceuticals' (USA) high-throughput DNA sequencing unit. Former collaborator of Nobel Laureate Prof. Jean Dausset. Inventor of new technologies in molecular biology. MRC Overseas fellow, Member of H.U.G.O., Wellcome Trust Systems Biology experts board. Member of the Cambridge Healthtech Institute Scientific Committee, Member of the Evaluation committee for the funding priorities in the “Medical Systems Biology- MedSys” program; German Federal ministry of Research. 14 original articles in international journals including Nature, Cell, Nature Genetics, Genomics, J Mol Endocrinol, J Comp Biochem Physiol. 7 international patents, 3 patent applications currently undergoing examination, 5 book chapters, numerous invited communications at international conferences.

- *Manuel Gea: C.E.O & VP R&D Information Systems. Information systems specialist:*

- Scientific Engineering Degree from Ecole Centrale Paris, Chairman of the Supervisory board of PHERECYDES PHARMA (anti-bacterial bio-agents pharmaceutical company); Former CEO Hemispherx Biopharma Europe. Founder and President of Centrale-Santé. Founding-Administrator of the computing firm Formitel. Former McKinsey executive, creator of Practice Pharma services in France. Former Division Managing Director with Boehringer-Ingelheim France. Former International business manager Colgate-Palmolive Company (US), Co-founder and Vice President of the Biotech Committee of the Association of the Pharma companies operating France (LEEM). Member of the executive board of Medicen Santé, the world-class bio-cluster of Paris region. Vice-President AdebioTech Committee. Co-founder and Evaluation Committee member of Paris Biotech (leading biotech incubator).

- *Gérard Dine (MD, PhD): Chief Medical Officer: Physician, biologist:*

- Head of the Haematology Dept. at Troye's hospital. Founding member and Head of the Biotechnology Dept. at Ecole Centrale Paris. Founding-President of Troye's Institute of Biotechnologies. Former President of the Institute for Sports Medicine.

- *Paul-Henri Lampe: CIO & Systems Integration Director. Systems Integration specialist* Scientific Engineering Degree from Ecole Centrale Lille. Master Degree in Applied Mathematics from Ecole Centrale Paris. Former IBM Systems Integration Manager. Former Information Systems projects manager in an Acute Care Hospital in Paris.

- *Pablo Santamaria: IT & Internet Systems Director. Internet technologies specialist:* Scientific Degree from Ecole Centrale Paris, Founder and President of the computing firm Formitel (1988) .Founding President of the Centrale-Ethics Think-Tank. Vice-President of Centrale Human Resources Professional group. Former Senior Consultant Information Systems Evaluation (INSEP). Former Industrial Maintenance Manager at Glaxo Pharma ( Evreux, France)

New collaborative R&D paradigm deciphered and its first operational successes in CNS, biodefense/biosecurity and Green Industrial Biotech

## **BMSystems: a collaborative biotech company focused on its core know-how to optimize time to market & R.O.I.**

- **Independent Private Company incorporated in 2004.**
- **Young Innovative Enterprise status since creation.**
- ***100% owned by its founders* (no search for external investors)**
- **A “*Biology*” driven company** that intensively uses I.T. resources.
- **Inventor and *exclusive owner of all its technologies.***
- **All non-strategic functions and resources are externalized.**
- **FTE\*: 9 scientists/professionals only focused on CADI™ research.**
- **Over 100 professionals are working on BMSystems’ related programs.**
- **Member of BiO (USA), MEDICEN, IAR (Industrial biotech) clusters.**
- **Member in France of Adebiotech, Medef, Centrale-Santé Think Tanks.**
- **Founders member of international organizations (HUGO, CHI, etc...)**
- **Controls 40% of its biopharmaceutical spin-off: Pherecydes-Pharma.**



For each CADI™ program, the company focus it R&D efforts on the internal construction of the CADI™ model and collaborates with the best partners that have experimental capacities and/or access to market. The valuable outputs will be co-developed

\*FTE: Full time Equivalent

# BMSystems' Mission

BMSystems is a research-based biotech company that creates CADI\*™ models to boost its clients/partners R&D programs with immediate applications generating highly attractive businesses

## *BMSystems research/business model:*

- BMSystems generates *innovative hypotheses* to create new knowledge from raw information through the construction of CADI™ models and,
- BMSystems generates *real & attractive business* from this new knowledge through its innovative business model.

*\*Computer Assisted Deductive Integration*

# BMSystems outputs

*What can we do with CADI™ models?*

*Reduce time to result, improve success rate and reduce development costs in the following markets, **biomedical, chemistry, environment, energy**, through:*

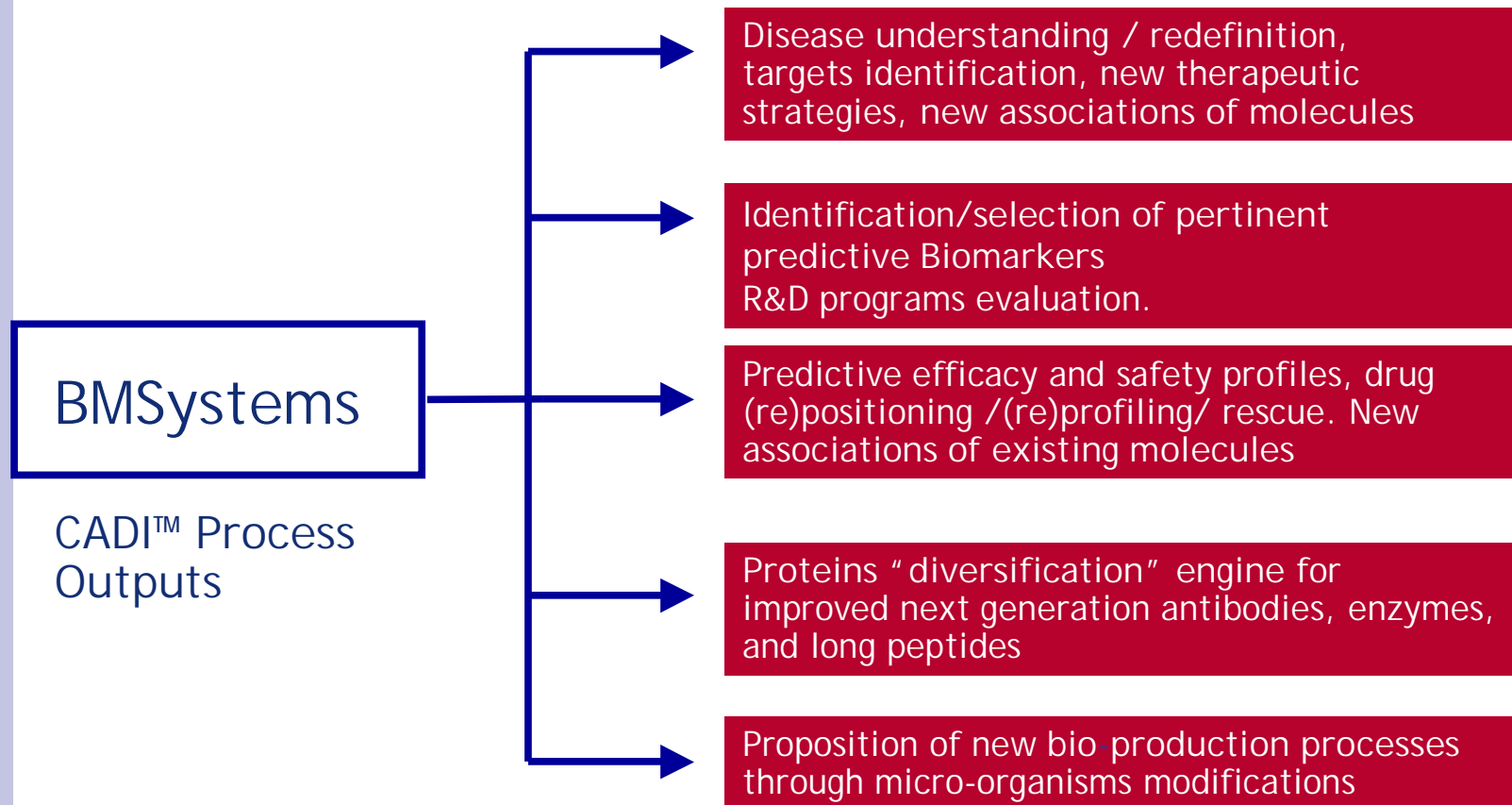

## A new collaborative strategy to optimize capital investments and time to market

### BMSystems' CADI™ research

#### *Academic Research* (4 publications)

- Access to experimentation for CADI™ models validation with institutions

#### *Technology Developments*

- CADI™ Processes and Tools, CADI™ Knowledge Database
- 4 Patents from CADI™ outputs (collaborative programs)

#### *Contract Research*

- Pharma, Biotech
- Chemical, Environment, Energy Industry

#### *Alliances/Consortiums / J. V.*

- *Synthons program (royalties)*: Industrial biotech
- *BioXplain*. Predictive and Integrative Biology Platform

#### *Spin-Offs*

- *Pherecydes-Pharma* (Nanotech bio-agents)
- New Company with CEA Life Sciences

# BMSystems' CADI™ programs to date

Program Name	Validation / Business Partner(s)	CADI™ compliance	CADI™ vers. 0	Ind. Valid.	Patents / Publi.	First Proof of Concept (POC)	Mid scale or preclinic. P.O.C.	Ready for Business
Nano-Bioagents	Pherecydes							
TAPE	Pherecydes							
Chronic Fatigue Syndrome	Open							
Ebola virus ecology	Open							
Hepatitis C	Open							
CNS-Psychiatry	CEA Life Sciences							
CNS-Neurodegenerative	CEA Life Sciences							
Fibromyalgia	Open							
Pain	Open							
Migraine	Open							
Multiple Sclerosis	Open							
Psychiatric disorders	Open							
Program Synthons	ARD-IBT-L'Oréal							
Program Synthons	ARD-IBT-Rhodia							
Program Synthons	ARD-IBT-Arkema							
Breast cancer-Hras	INSERM							
Tamoxifen resistance	INSERM							
Metastasis mechanism	INSERM							
Müllerian regression	CNRS							
Adipocytes growth control	Open							
Hypercholestermia	Open							
Metabolic Syndrome	Open							

Infection-Immunology

Oncology

CNS-PNS

Tissue Differentiation

Industrial biotech

Metabolism

# BMSystems' 4 case studies

*The Proof through operational achievements*

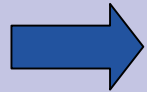

*New therapeutic strategy:* Publication, in 2003, with the INSERM unit 553, of the first independently validated in-silico model of a complex human disease.

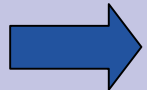

*Spin-Off:* 3 patented new disruptive technologies & successful launch and financing of Pherecydes-Pharma, the first bio-defence and bio-security company in France to efficiently & reliably address first bacterial threats, next viruses, and then toxin threats.

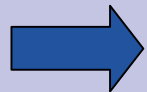

*Consortium:* Co-founder in 2006, as integrative biology partner, with its key partners A.R.D., I.B.T. and C.V.G., of the Synthons platform, the major integrated collaborative industrial biotech platform in France,

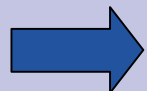
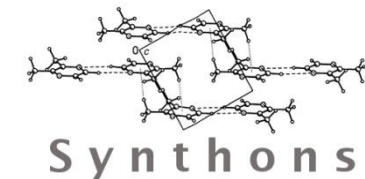

*Industry Award & patent :* This collaborative work received a Bio-IT World 2009 Best Practice Award. A second CADI™ modeling program with the same CEA-SEPIA\* research team also allowed the discovery of novel therapeutic approaches in the treatment of poorly served CNS diseases (patent filed).



\*CEA-SEPIA: Atomic Energy Council: Department of prion and atypical infections research

# 1-Ras-dependent breast cancer

Tumour Progression: *MCF-7 vs MCF-7 ras*



The theoretical model made three types of predictions:

Published in: *Nucleic Acids Research*, 2003, Vol. 31, No. 19: 5789-5804

## -A) *the cellular mechanisms.*

The model predicted the expression patterns of 13 key genes associated with the physiological changes revealed during the model-building process.

These predictions were independently tested, using RNA-chip technologies, at Hospital Tenon.

## -B) *the therapeutic targets*

The model indicated three different cellular processes as being key to the maintenance of the hormono-sensitive malignant state. In each case clearly defined protein targets (isoforms level) were identified.

## -C) *the types of therapeutic interventions required*

The model indicated three different molecules which, in combination and at sub-optimal concentrations, would have the required effects on the protein targets of cancer cells, leaving non-cancer cells largely unaffected.

These predictions were directly and independently tested on the cells by cancer specialists INSERM U 553 at Hospital Avicenne (Prof.M.Crépin), and the CEPH Institute (Prof.L.Cazes) in Paris.

# 1-Ras-dependent breast cancer

*Biological Validation. A significant difference when the three compounds, NEVER USED IN CANCERS, are present*

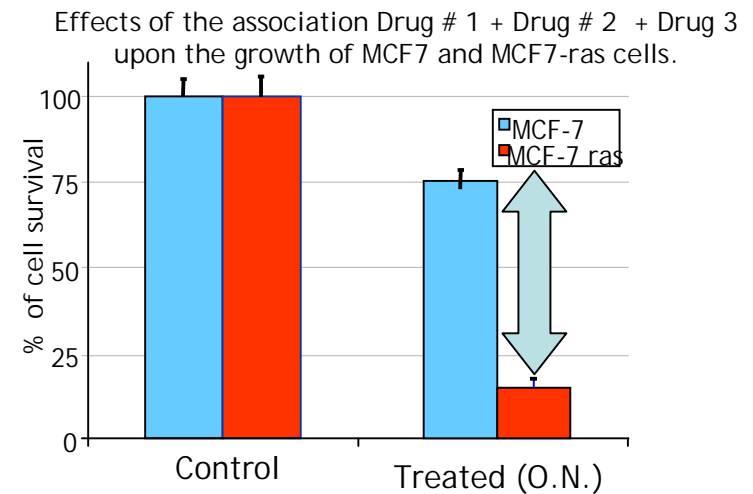
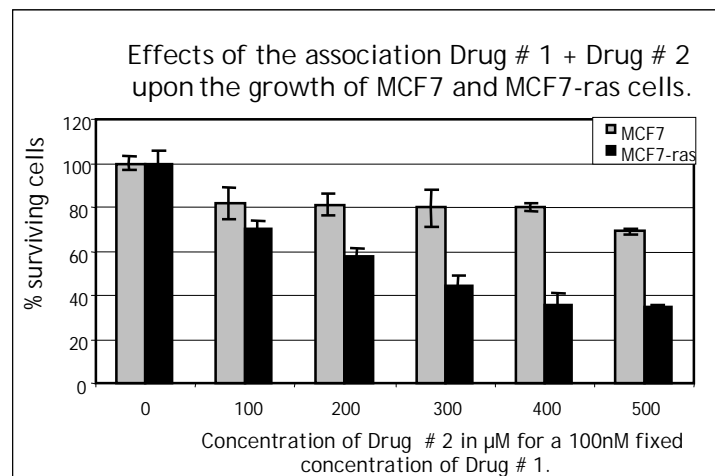
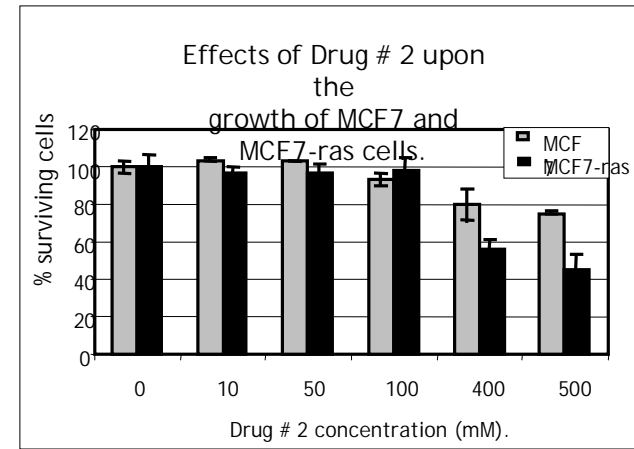
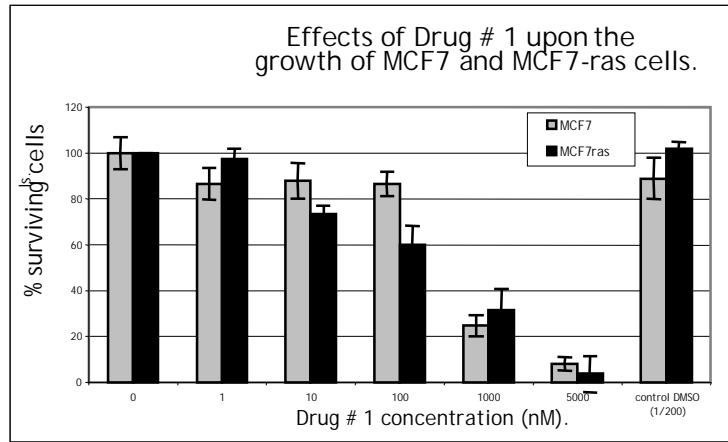

**This is not a treatment, but this work gives new patentable ideas to develop new therapeutic strategies using a combination existing and/or new drugs.**

# BMSystems' Heuristic CADI™ approach

Illustration: The bacterial mechanisms and their business applications

Pherecydes-Pharma  
Biodefense-biosecurity  
Partners: ACE management, CEA

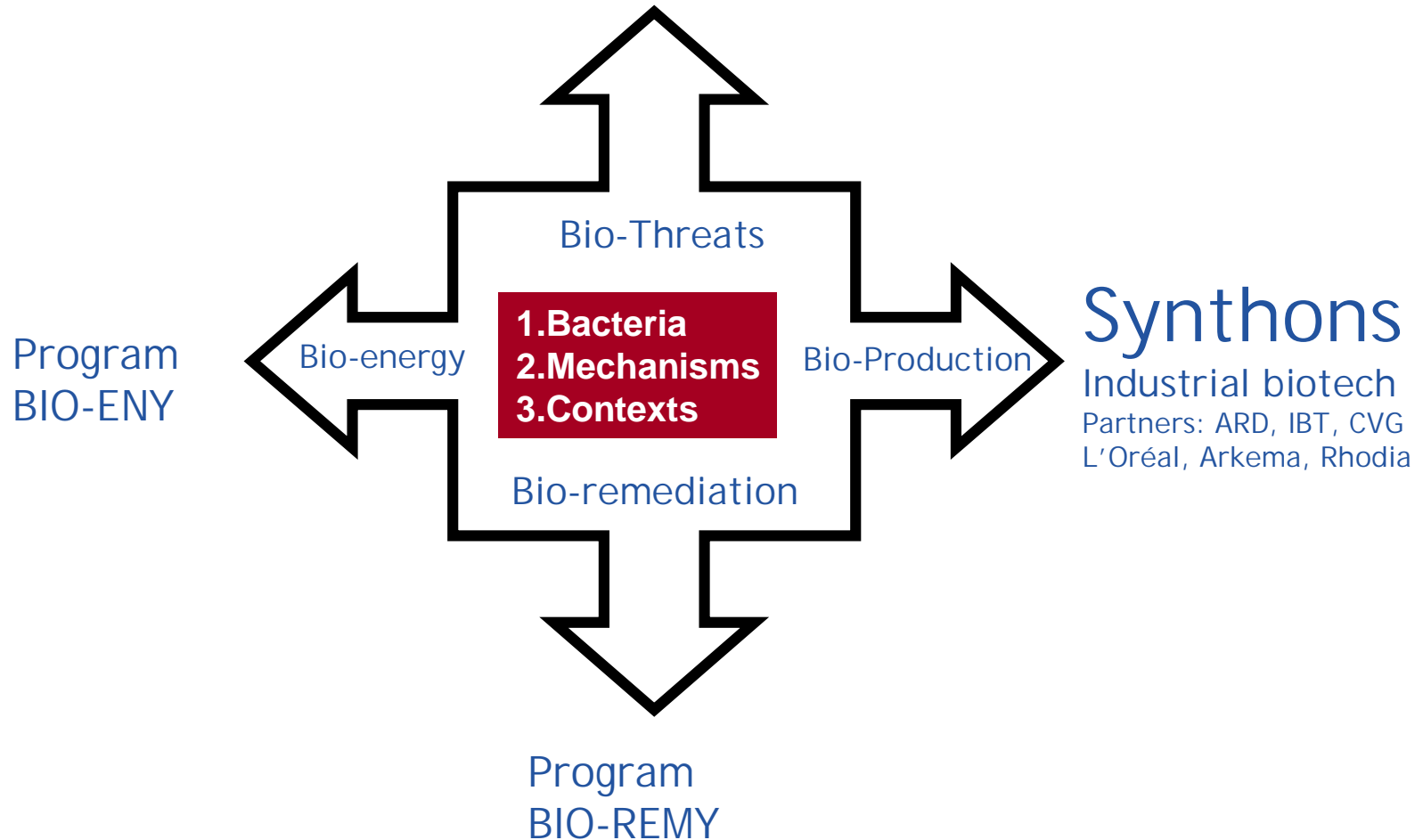

## 2. Pherecydes-Pharma

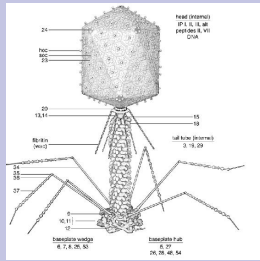

**PHERECYDES-PHARMA: Less than 5 years from concept to industrial proof in the field of biodefense /biosecurity.**

- **World's 1<sup>st</sup> company created from an integrative systems biology program**
- **Creation of the *first operational large-scale engineered bacteriophage bank* to fight against “*unknown multi-resistant*” bacterial infections.**
- ***Outstanding support from CEA Fontenay-aux Roses* (founding member of Medicen cluster), including IMETI\* Institute's scientific team.**
- **Creation Dec. 2006: *1.15 Million € raised*, from ACE management funds.**
- ***500 k € Innovation Program grant* from Oséo Innovation Agency.**
- **Rapid international recognition in the USA (*4 invitations to present*).**
- ***3 fully owned international patents* invented by BMSystems.**
- ***Industrial proof of concept: Sept. 2009.***
- **April 2010: signs its *first international collaboration with BAC (Bio Affinity Company) BV* to develop improved antibodies and is negotiating 2 others in N. America.**
- **Pherecydes Pharma is member of Medicen and is also supported by the Lyon Biopôle cluster.**



**Clearly, the outstanding collaboration & support from CEA life Sciences Fontenay-aux-Roses, led to Pherecydes-Pharma being located in France**

\*Pr. Leboulch, Jean-Philippe Deslys, Franck Mouthon and Pierre Chagvardieff

# 3. Synthons Program

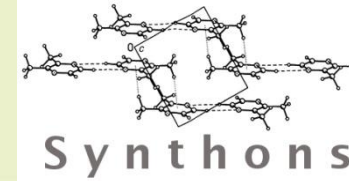

**Synthons program, major collaborative industrial biotech research platform in the IAR world-class cluster**

## **A complementary collaborative team:**

- **A.R.D.:** Leading Industrial Biotech research company with experimental capacities, pilot scale-up, pilot plant (2000 Tons), etc.
- **I.B.T.:** One of France's leading Technology Transfer Institutes.
- **BMSystems:** integrative Biology & metabolic engineering expertise.
- **C.V.G.:** "green chemical" sourcing research institute.

## **3 EU chemical companies proposing their molecules to the platform:**

- **L'Oréal:** (world leader in cosmetics)
- **Rhodia:** (ex Sanofi Aventis fine chemical entity)
- **Arkema:** (ex Total chemical entity)

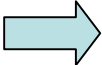

2 engineered strains generated are under evaluation and a finalized process under mid-scale validation. The program is funded by the ministry of Industry and supported by IAR world-class cluster

## 4. CNS research programs



### The double take win-win CNS programs

1. 2008: *World's first in-vivo validation of a CADI™ in-silico model* of a complex human disease (Creutzfeldt-Jakob/prion disease) with CEA SEPIA\*, coordinator of the European NeuroPrion Network of Excellence. Discovery of a new regulation system in the brain. (publi. Pending)



The program received a prestigious US Industry Award:  
Bio-IT World 2009 Best Practice Award  
The only EU team rewarded in 2009



2. 2009: *New industrial application*: A 2<sup>nd</sup> CADI™ model with the same research team, exploiting one discovery of the 1<sup>st</sup> CADI™ model, led to the discovery of novel therapeutic approaches in the treatment of poorly served psychiatric diseases (patent filed Sept 2008).



In 2009, BMSystems and CEA Life Sciences decided to support a spin-off research team to develop the patent.



\*CEA (Atomic Research Council) Department of prion and atypical infections research (SEPIA) A department of the CEA IMETI Institute. Jean-Philippe Deslys, Franck Mouthon and Pierre Chagvardieff.

## Key learnings to really support disruptive innovative SMEs

- **Be aware that SMEs can “also” generate disruptive R&D paradigms, but they need open minded partners to have access to costly equipments and/or complementary academic expertise.**
- **The expertise issue: The “classical” experts, well adapted to “incremental” progress, represent the major issue in the evaluation of disruptive innovations. We appreciate that it is difficult to objectively evaluate something you can’t understand!**
- **Based on our experience, the first impulse of the expert may be to state that “it is impossible” and then, when the first results are observed, to try obtaining the “secrets” in order to understand or, failing that, to claim “other reasons”.**
- **The SMEs managers know that the value of “secret agreements” and patents protecting innovations are directly proportional to the amount of money they are ready to spend to defend them!**

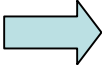

SMEs are ready to participate to Collaborative European Programs, they are attractive, but the evaluation rules must be “more transparent”, and the selection of experts and their briefing need to be adapted to the type of innovation presented and integrate an understanding of SMEs factual life.

New collaborative R&D paradigm deciphered and its first operational successes in CNS, biodefense/biosecurity and Green Industrial Biotech

## Conclusions / Questions



For more information:

- [www.bmsystems.net](http://www.bmsystems.net)
- [www.pherecydes-pharma.com](http://www.pherecydes-pharma.com)
- Email: [manuel.gea@bmsystems.net](mailto:manuel.gea@bmsystems.net)